



**new era**  
floor levelling systems

# **GYMFLEX**®

**A NEW ERA IN SPORTS PERFORMANCE FLOORING**



[www.newerafloorsystems.co.uk](http://www.newerafloorsystems.co.uk)



# GYMFLEX<sup>®</sup>

A **NEW ERA** IN SPORTS PERFORMANCE FLOORING



**NBS Source**  
PARTNER



# INDEX

Page 4-6

STUDIO

Page 7-8

DANCE

Page 9-11

ACTIVE

Page 12-13

ARENA

Page 14

FITNESS LVT

Page 15

FITNESS RUBBER

Page 16-17

FITNESS UP (LVT)

Page 18-20

FITNESS UP (RUBBER)

Page 21-25

COMPONENTS

Page 26-28

MAINTENANCE



[www.newerafloorsystems.co.uk](http://www.newerafloorsystems.co.uk)

 03438 410115



GYMFLEX SPORTS FLOOR

GYMFLEX SPORTS UNDERLAY  
5MM THICKNESS

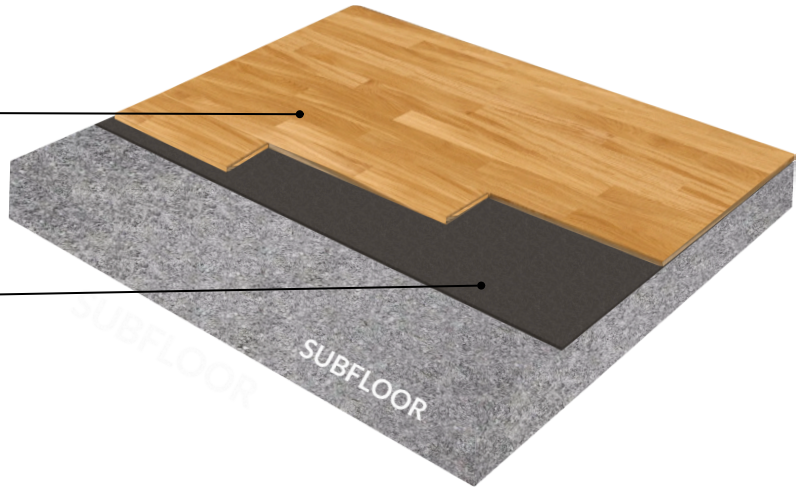

'Studio' is an area Elastic floor with excellent comfort & flexibility making it suitable for Dance Studios, Gyms and multi-use spaces. The 19mm overall floor build up makes it the perfect choice for renovation projects and laying over suitable existing substrates, whilst the easy installation makes it quick and efficient to save any down time.

- Quick & Easy Installation
- Great Comfort & Flexibility
- Only 19mm overall floor height
- Available in Beech or Oak Finishes
- 2-strip format
- Board size 14mm x 129 x 1830mm
- Pack size 8 boards = 1.89m<sup>2</sup> (18.71kg)
- 5mm Underlay
- Suitable for underfloor heating
- PEFC Certified

Catagory	Specifications
Floor Height	19mm
Performance	BSEN14904
Floor Type	Beech or Oak
Floor Size	350m <sup>2</sup>
Weight Limit	350kg Per m <sup>2</sup> – Static load
Sustainability	PEFC

The Gymflex Studio pre-finished finished floor is available in a range of different colour options to help with expression and creativity, which will enhance any Studio space with a great contemporary decor, whilst delivering the performance required.

### GYMFLEX STUDIO FLOOR FINISH OPTIONS



RUMBA



SAMBA

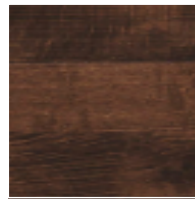

CUBAN

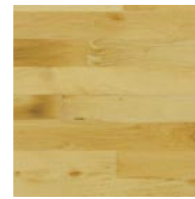

NATURAL



FUMED

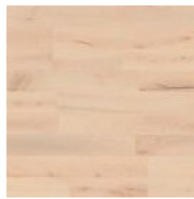

MIST

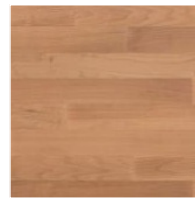

FUMED MIST

### GYMFLEX STUDIO LAYOUT

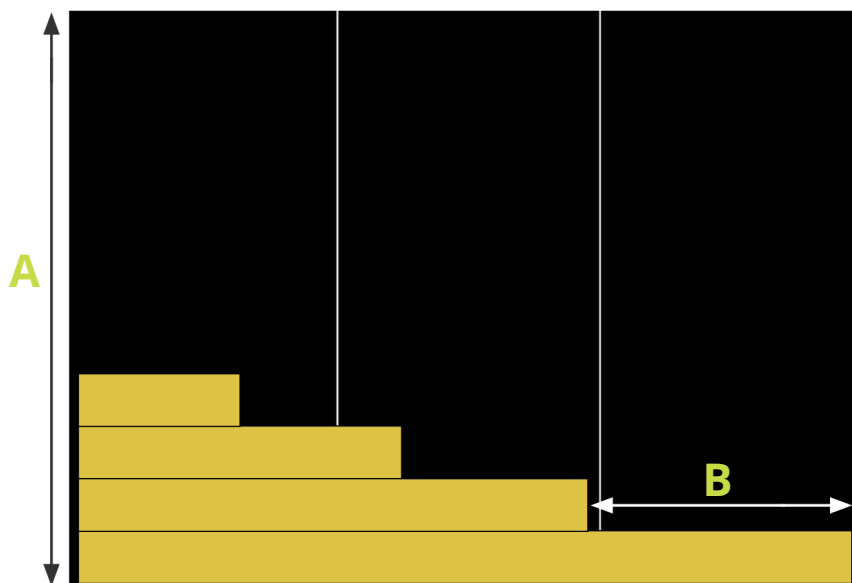

Layout  
>

**A** Underlay to be rolled out perpendicular to flooring

**B** board stagger 732mm



Gymflex Dance is a high performance hardwood floor system designed to create a unique and responsive floor to suit all different Dance Genres. The area elastic properties are enhanced by the development of the sub-floor layout to optimise the agility and expression of the dancer to help achieve their full potential. Though extensive research it has been widely considered that a large number of dance related injuries have been due to irregular shock absorption in the sprung floor, therefore makes the consistently uniform Gymflex Dance floor the perfect choice for Performing Arts.

The slip resistance is an important factor when considering Dance floors, which is why we have used the best hard wearing lacquered finish to give the perfect balance between grip and slide, which is essential for all dance routines. - Gymflex Dance can achieve a height range of between 74-350mm using the unique New Era Performance cradle system, suitable for Dance Studios and performance spaces up to 600m2 and has been approved and tested for Acoustic impact sound isolation properties, making it ideal for studios on upper levels.

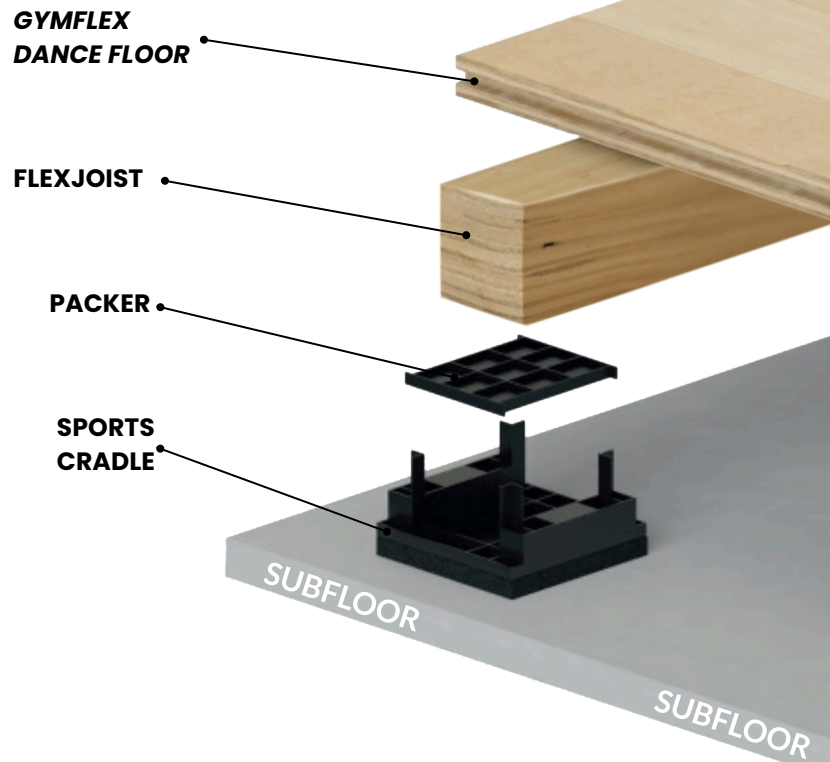

Category	Specifications
Board Dimension	22 x 129 x 1830mm
Flexjoist Centres	366mm
Performance	BSEN14904
Friction	85
Floor Height Range	74 - 350mm
Acoustic	25db sound reduction
Sustainability	PEFC



The Gymflex dance finished floor is available in a range of different colour options to help with the expression and creativity, which will enhance any Performing Arts space with a great contemporary decor, whilst delivering the performance required.

### GYMFLEX DANCE FLOOR FINISH OPTIONS



RUMBA



SAMBA

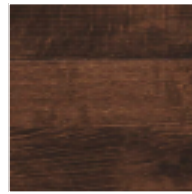

CUBAN

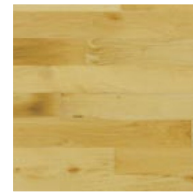

NATURAL

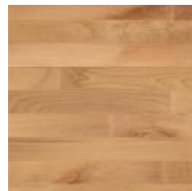

FUMED

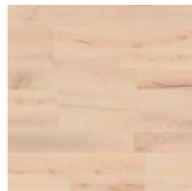

MIST

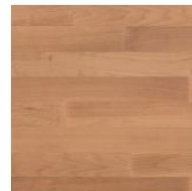

FUMED MIST

### GYMFLEX DANCE FLEXJOIST & DIAMOND CRADLE LAYOUT

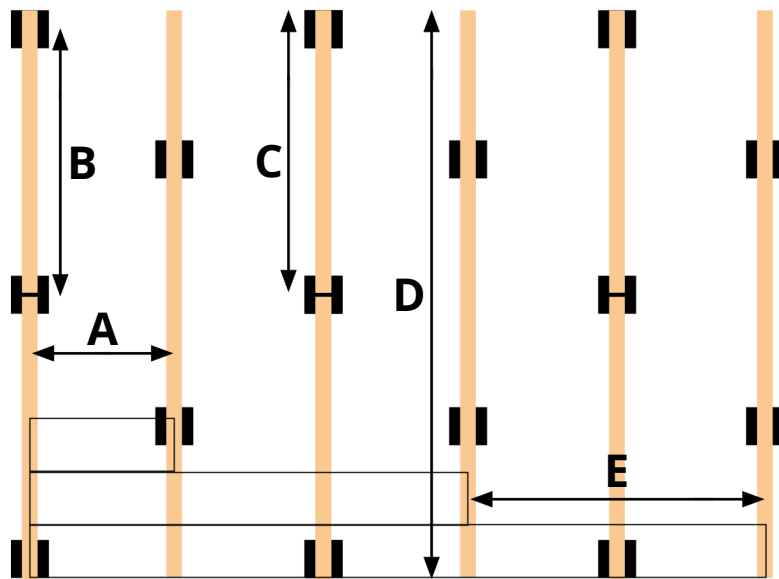

Flexjoist size

		A	B		C	D		E
36mm	Layout >	Flexjoists 366mm	Cradles 450mm	Flexjoist Stagger >	Flexjoists 900mm	Flexjoists 1800mm	Floor Stagger >	Floor 732mm
48mm		Flexjoists 366mm	Cradles 600mm		Flexjoists 1200mm	Flexjoists 1800mm		Floor 732mm

Gymflex Active is a high performance hardwood floor system with a height range of 74–350mm using the unique New Era sports cradles and suitable for gym and fitness areas up to 350m<sup>2</sup> or below. The additional structural supports provides extra strength to allow more surface loading and impacts, whilst still offering the sprung floor standard and excellent acoustic isolation needed when used on upper levels.

Gymflex Active can be supplied in either solid beech, Layered beech or oak floor finishes and used in conjunction with Gymflex rubber tiles on top, which will provide areas for free-weights to protect the surface finish.

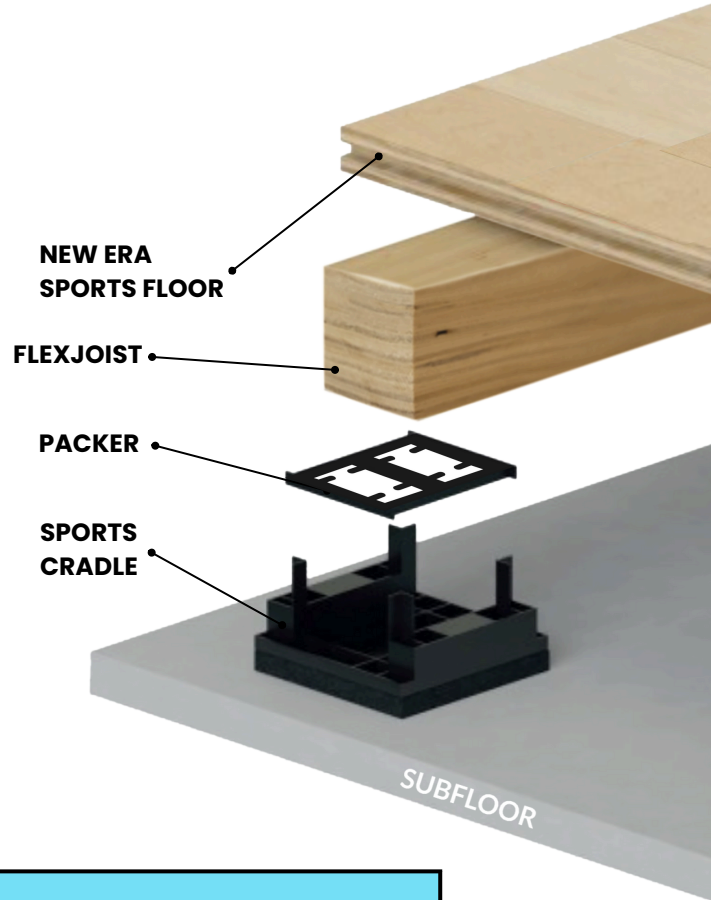

Category	Specifications
Floor Height	74–350mm
Performance	BSEN 14904 Part A3
Floor Type	Solid Beech
Flexjoist Centres	336mm
Floor Dimension	22 x 129 x 1830mm
Max floor size	600m <sup>2</sup>
Substructure	New Era sport cradle & Flexjoists
Weight Limit	350kg point & 500kg static Load (M2)
Sustainability	FSC
Acoustic	25db Reduction

The Gymflex Active pre-finished floor is available in a range of different colour options to help with the expression and creativity, which will enhance any Multi-use space with a great contemporary decor, whilst delivering the performance required.

### GYMFLEX ACTIVE FLOOR FINISH OPTIONS



RUMBA



SAMBA

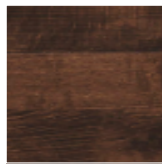

CUBAN



NATURAL

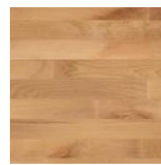

FUMED

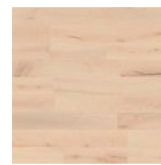

MIST

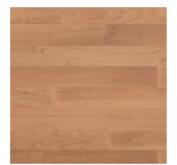

FUMED MIST

### GYMFLEX ACTIVE LAYERED FLOOR FINISH OPTIONS



OAK

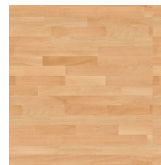

BEECH

### GYMFLEX ACTIVE FLEXJOIST & CRADLE LAYOUT

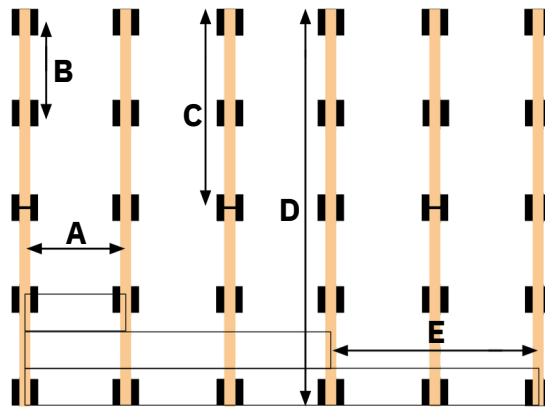

#### Solid Flooring

Flexjoist size

		A	B		C	D		E
36mm	Layout >	Flexjoists 366mm	Cradles 450mm	Flexjoist Stagger >	Flexjoists 900mm	Flexjoists 1800mm	Floor Stagger >	Floor 732mm
48mm		Flexjoists 366mm	Cradles 600mm		Flexjoists 1200mm	Flexjoists 1800mm		Floor 732mm

#### Layered Flooring

36mm	Layout >	Flexjoists 366mm	Cradles 450mm	Flexjoist Stagger >	Flexjoists 900mm	Flexjoists 1800mm	Floor Stagger >	Floor 732mm
48mm		Flexjoists 366mm	Cradles 600mm		Flexjoists 1200mm	Flexjoists 1800mm		Floor 732mm



# GYMFLEX<sup>®</sup>

**A NEW ERA IN SPORTS PERFORMANCE FLOORING**

Gymflex Arena is the highest performance floor for large sports halls that require the best in area elastic standards. With a height range of 74-350mm achieved using the unique New Era sports cradles, it can overcome the most challenging of levels whilst meeting EN14904 Part A4 standard.

Perfect for new builds and sports floor replacement, it can also achieve excellent acoustic standards when using on upper levels. Can be supported with extra strength Flexjoists to enable to roll out of bleacher seating or additional support requirements, (Subject to job specific data).

## ARENA

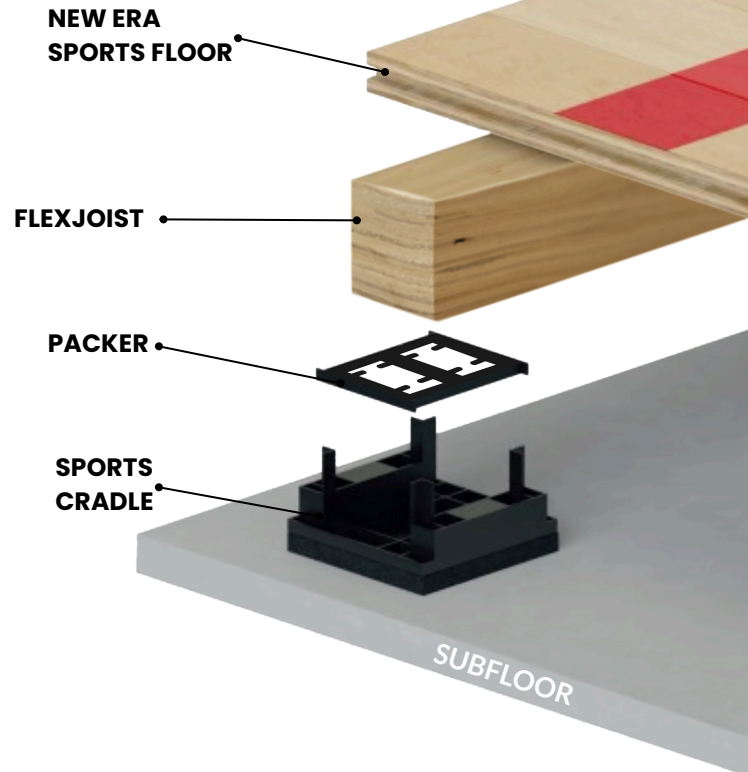

Category	Solid Floor	Layered Flooring
Floor Height	74-350mm	73-350mm
Performance	BSEN 14904 Part A4	BSEN 14904 Part A4
Floor Type	Solid Beech	Layered Beech or Oak
Flexjoist Centres	411mm	440mm
Floor Dimension	22 x 129 x 3700mm	21 x 215 x 2200mm
Max floor size	Unlimited	Unlimited
Substructure	New Era sport cradle & Flexjoists	New Era sport cradle & Flexjoists
Weight Limit	350kg point & 500kg static Load (M2)	350kg point & 500kg static Load (M2)
Sustainability	FSC	FSC
Acoustic	25db Reduction	25db Reduction

The Gymflex Arena pre-finished floor is available in a range of different colour options to help with the expression and creativity, which will enhance any Sports Hall or Arena, with a great contemporary decor, whilst delivering the performance required.

### GYMFLEX ARENA FLOOR FINISH OPTIONS

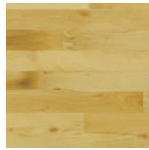

NATURAL

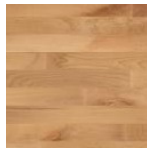

FUMED

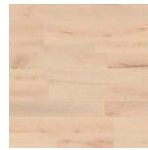

MIST

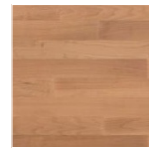

FUMED MIST

### GYMFLEX ARENA LAYERED FLOOR FINISH OPTIONS



OAK

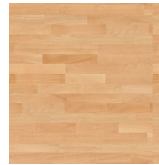

BEECH

### GYMFLEX ARENA FLEXJOIST & CRADLE LAYOUT

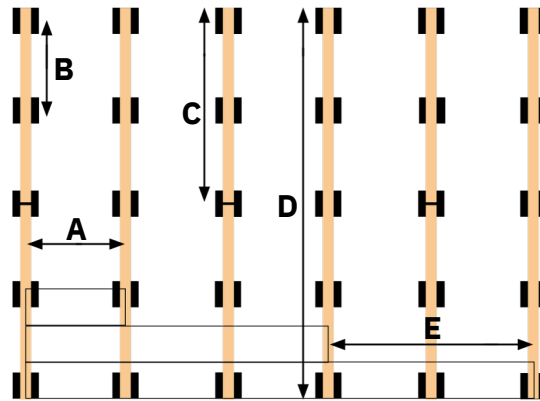

#### SOLID FLOORING

Flexjoist size

		A	B		C	D		E
36mm	Layout	Flexjoists 411mm	Cradles 450mm	Flexjoist Stagger >	Flexjoists 900mm	Flexjoists 1800mm	Floor Stagger >	Floor 822mm
48mm	>	Flexjoists 411mm	Cradles 600mm		Flexjoists 1200mm	Flexjoists 1800mm		Floor 822mm

#### LAYERED FLOORING

36mm	Layout	Flexjoists 440mm	Cradles 450mm	Flexjoist Stagger >	Flexjoists 900mm	Flexjoists 1800mm	Floor Stagger >	Floor 440mm
48mm	>	Flexjoists 440mm	Cradles 600mm		Flexjoists 1200mm	Flexjoists 1800mm		Floor 440mm

Gymflex Fitness LVT is a luxurious vinyl wood plank design, which is a fast fit solution for quick renovations with minimal downtime. The beautiful wood effect design is water and stain resistant and very durable to withstand multi use activities.



**GYMFLEX FITNESS LVT FLOOR FINISH OPTIONS**

The Gymflex Fitness LVT floor is available in a range of contemporary finishes



**GOLDEN LVT**



**LINEN LVT**



**GREY LVT**

Category	Specifications
Board Dimension	5 x 190 x 1230mm
Install	glue down
Application	Overlay of existing floors, Spin Studios, Fitness Suites, Gym, Schools, Offices, Shops
Features	Water Resistant, Stain Resistant, Slip Resistant 36+ PTV (wet) Scratch Resistant



Fitness 20 & 40mm are a low height interlocking rubber tile that are easy to install, whilst being tough and resilient for multiple applications. This unique two piece construction has a durable recycled rubber top with a foam backing for anti-fatigue purposes. This offers enhanced shock absorption, and much better comfort underfoot.



20mm Rubber Tile



40mm Rubber Tile



Category	Specifications	Specifications
USE	Moderate/Heavy Free Weights, Main Gym Areas	Moderate/Heavy Free Weights, Main Gym Areas
THICKNESS	20mm	40mm
SIZE	20mm x 1000mm x 1000mm tile	40mm x 1000mm x 500mm tile
MATERIALS	Recycled Rubber & EDPM	Recycled Rubber & EDPM
ACOUSTIC	20mm tile: 21 DB reduction	40mm tile: 28 DB reduction
COLOURS	Black with light grey fleck	Black with light grey fleck
WARRANTY	5 Years	5 Years
INSTALLATION	loose lay with connector system set at 200mm intervals	loose lay with connector system set at 200mm intervals





Gymflex LVT up is a luxurious wood plank design, which has a beautiful wood effect design that is water resistant and very durable. The raised elevation of the sprung Cradle & Flexjoist system makes this extremely versatile and suitable for areas that require acoustic isolation, whilst not compromising the performance. The Lvt is available in 3 colour choices and make a perfect alternative to real wood flooring.

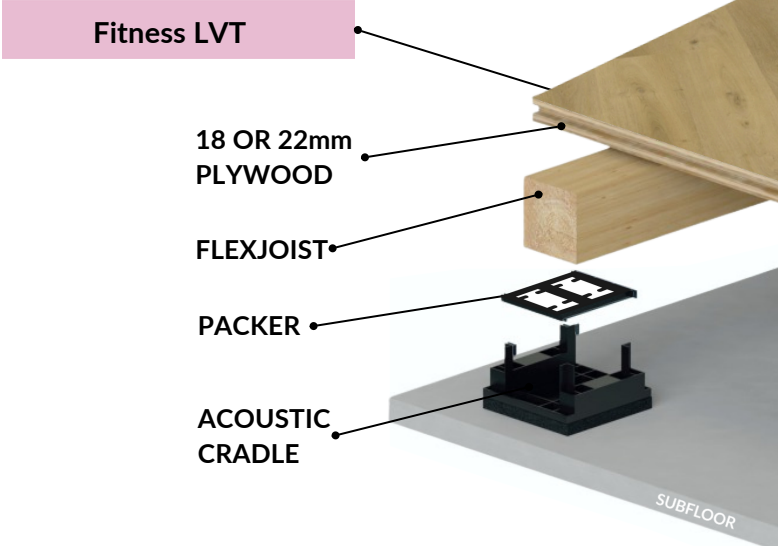

Category	Specifications
Floor Type	LVT
Board Dimension	5 x 190 x 1230mm
Install	glue down
Floor Height	75-295mm
Flexjoist Centres	400mm
Weight Limit	350kg point & 500kg static load (m2)
Substructure	New Era Cradle & Flexjoists with plywood
Acoustic	25db Reduction

**GYMFLEX FITNESS UP LVT FLOOR FINISH OPTIONS**

The Gymflex Fitness LVT floor is available in a range of contemporary finishes.



GOLDEN LVT



LINEN LVT



GREY LVT

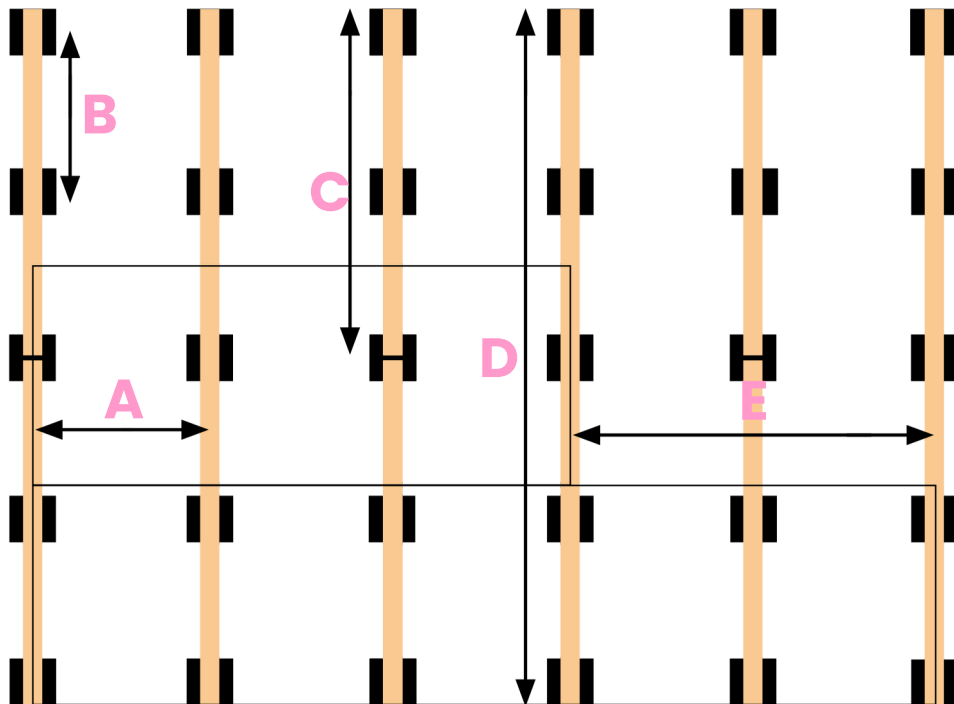

Flexjoist size		A	B		C	D		E
36mm	Layout >	Flexjoists 400mm	Cradles 450mm	Flexjoist Stagger >	Flexjoists 900mm	Flexjoists 1800mm	Floor Stagger >	Floor 1200mm
48mm		Flexjoists 400mm	Cradles 600mm		Flexjoists 1200mm	Flexjoists 1800mm		Floor 1200mm

Gymflex Fitness Up recycled Rubber tiles are incredibly durable & tough, which have an extremely dense top layer designed to provide superior impact protection against the continuous dropping of free weights.

The raised Elevation of the Acoustic cradle and Flexjoist system makes this system extremely versatile and suitable for areas that require acoustic isolation, whilst not compromising the performance.

Available in 20 or 40mm thickness, the Gymflex Rubber provides an excellent floor surface for Studios that require intensive shock absorption and additional strength to take more extreme activities.

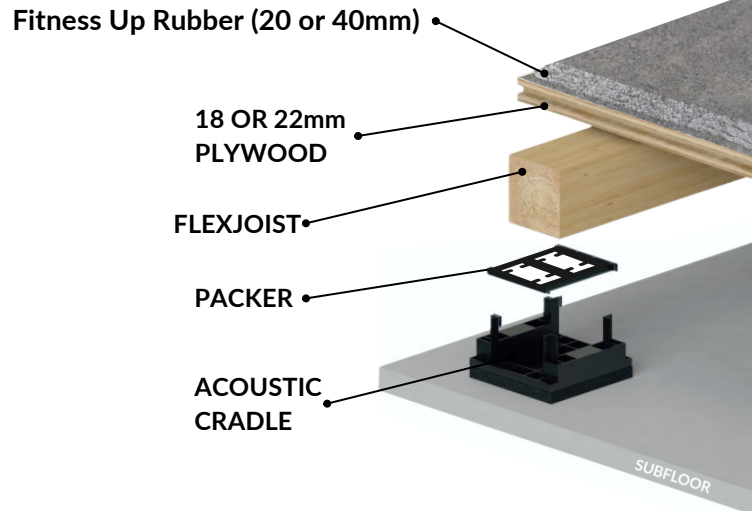

Category	Specifications	Specifications
Tile Thickness	20mm	40mm
Tile Size	1000 x 1000mm	1000 x 500mm
Install	loose lay	loose lay
Floor Height	90 - 310mm	110 - 330mm
Flexjoist Centres	300mm	300mm
Weight Limit	350kg point & 500kg static load (m2)	350kg point & 500kg static load (m2)
Acoustic	25db reduction	25db reduction



The Gymflex Fitness Up Rubber is available in two thicknesses, 20 & 40mm Black with Grey Fleck Rubber.

### GYMFLEX FITNESS UP RUBBER FLOOR FINISH OPTIONS

20mm Rubber Tile



40mm Rubber Tile



### GYMFLEX FITNESS UP RUBBER FLEXJOIST & CRADLE LAYOUT

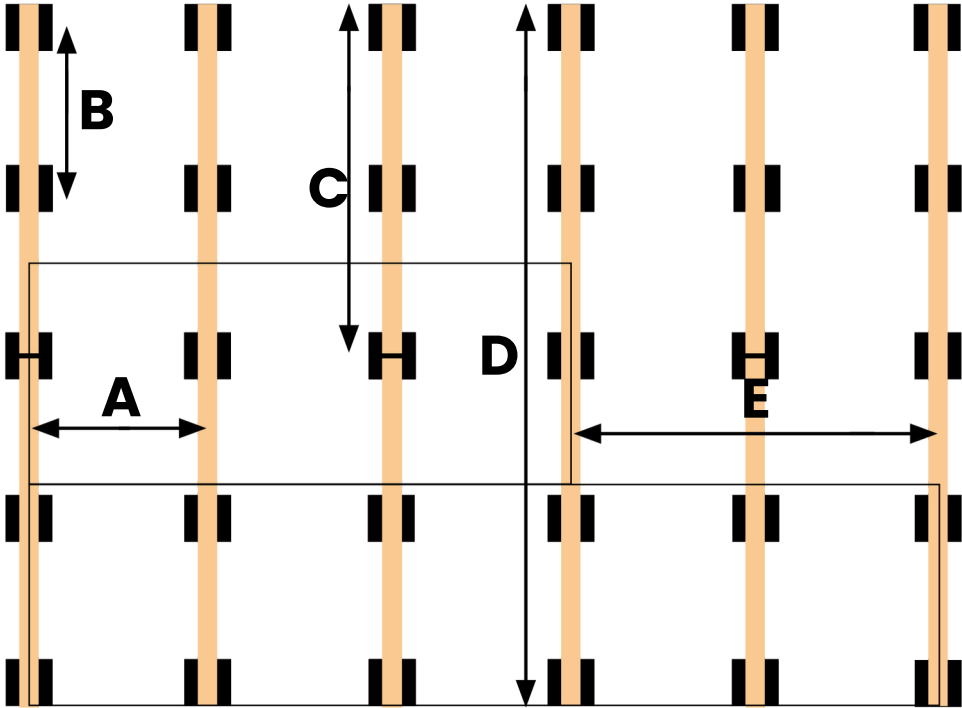

Flexjoist size		A	B			E
36mm	Layout	Flexjoists 300mm	Cradles 450mm	Flexjoist Stagger	Flexjoists 900mm	Floor 1200mm
48mm		Flexjoists 300mm	Cradles 600mm		Flexjoists 1200mm	Floor 1200mm



# COMPONENTS

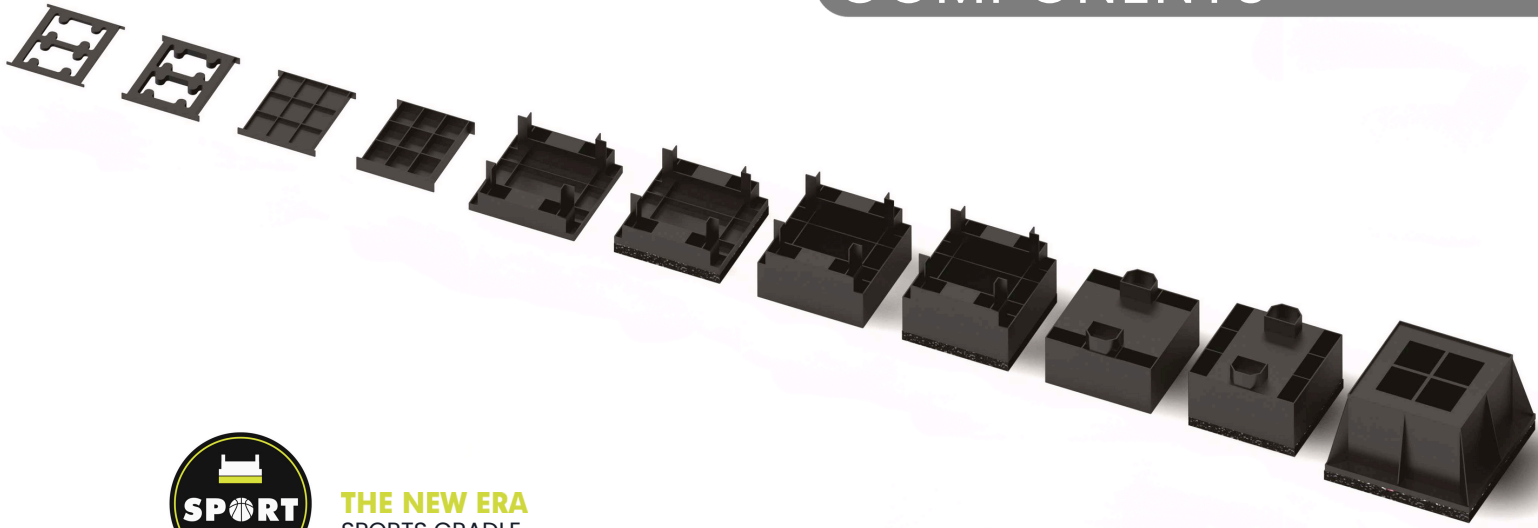

**THE NEW ERA**  
SPORTS CRADLE

**New Era Sports Cradles are suitable for high Performance sports, dance and Multi-purpose use and have been tested at the Centre of Sports Technology and conform to En14904: Class A4.\***

The Performance memory foam pad provides excellent resilience to sports impacts and will give a perfect floor for all activities.

\*Subject to certain criteria to ensure compliance.

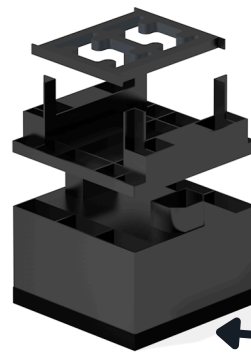

Evazote Memory Foam Pads



**THE NEW ERA** ACOUSTIC CRADLE

**New Era Acoustic cradles offer a high Performance of impact sound insulation and will offer up to 28db reduction on sound transfer when used on upper floors, making this perfect for new build specifications or renovations. The recycled rubber isolation pad will offer excellent loading and is ideal for all surfaces, whether free weights or general use. The acoustic cradles have been extensively tested at the AIRO laboratory in compliance with the Robust Detail Handbook, FFT2 Resilient Cradle and Flexjoist system.**

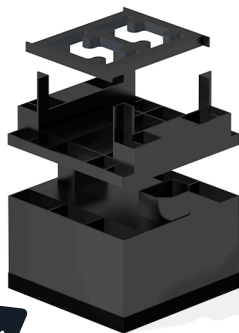

Recycled Rubber

## GYMFLEX SOLID FLOORING



flooring available in 14mm with the below finish options  
format 2-strip T&G  
board size: 22x129x1830mm  
suitable for under floor heating  
FSC certified

### GYMFLEX SOLID FLOOR FINISH OPTIONS



RUMBA

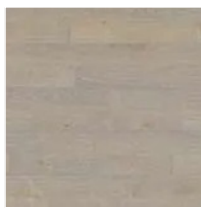

SAMBA

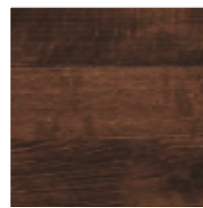

CUBAN

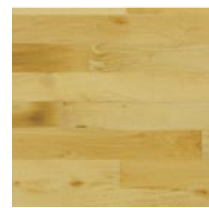

NATURAL

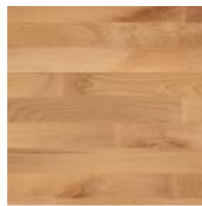

FUMED

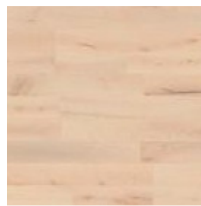

MIST

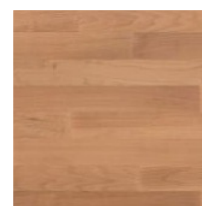

FUMED MIST

## GYMFLEX LAYERED FLOORING



Flooring available in Beech or Oak  
format: 3-strip T&G  
board size: 21x215x2200mm  
top layer: 5.5mm hardwood  
suitable for under floor heating  
FSC certified

### GYMFLEX LAYERED FLOOR FINISH OPTIONS



OAK

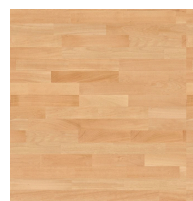

BEECH

## GYMFLEX LVT FLOORING



**Gymflex Fitness LVT is a luxurious vinyl wood plank design, which is a fast fit solution for quick renovations with minimal downtime. The beautiful wood effect design is water and stain resistant and very durable to withstand multi use activities.**

### GYMFLEX FITNESS LVT FLOOR FINISH OPTIONS



GOLDEN LVT



LINEN LVT



GREY LVT

## GYMFLEX RUBBER FLOORING



**Gymflex Rubber 20 & 40mm are a low height interlocking rubber tile that are easy to install, whilst being tough and resilient for multiple applications. This unique two piece construction has a durable recycled rubber top with a foam backing for anti-fatigue purposes. This offers enhanced shock absorption, and much better comfort underfoot.**

### RUBBER FLOOR FINISH OPTIONS



20mm Rubber Tile



40mm Rubber Tile



## GYMFLEX PLYWOOD



**New Era T&G plywood is an engineered plywood flooring panel specifically designed for use in house building, light industrial and commercial applications.**

WISA-Sprucefloor 600 TG4	18 mm	22 mm
<b>Nominal and laid size/measure</b>	2400 x 600 mm	2400 x 600 mm
<b>Edge profile</b>	TG4	TG4
<b>Weight per board (at 10 % m.c)</b>	12 kg	15 kg
<b>Boards per pack</b>	100	82
<b>Laid per pack</b>	97.92 m <sup>2</sup>	80.64 m <sup>2</sup>
<b>Volume per pack</b>	2.6 m <sup>3</sup>	2.6 m <sup>3</sup>
<b>Weight per pack</b>	1220 kg	1280 kg
<b>Sustainability Certifications</b>	BREEAM Hea 9/Hea02 (VOC's).	CE marked EN636-2 S

## GYMFLEX LAMINATED FLEXJOIST



**New Era LVL laminated Flexjoists are unique and specially manufactured from poplar plywood to add to the Performance of the cradle system. Available for the sports range in 36,48 & 63mm thickness, the Flexjoists have no weaknesses from knots or imperceptions and will not twist or warp in use.**

Flexjoist Size	Width	Length	Pallet Quantity
36mm	45mm	1800mm	800
48mm	45mm	1800mm	560
63mm	45mm	2100mm	420



New Era Gymflex wood flooring is a high Performance sports surface that will last a long time when looked after to maintain the high performance floor surface and prolong the life of the floor we recommend the following:

<b>Daily Cleaning</b>	<b>Sweep and remove debris using an anti-static mop or similar.</b>
<b>Cleaning every 1-2 weeks</b>	<b>Use NE Clean solution to clean floor using mop or mechanical</b>
<b>Buff &amp; Seal</b>	<b>Approx every 18 months we recommend a deep clean, buff and application of NE Sports lacquer to ensure surface remain in good condition.</b>
<b>Sand and seal</b>	<b>Normal use would mean sand and reseal are needed approximately every 7 years. This would be full sand back to bare wood and the use of the NE Prime and 3 coats of NE lacquer.</b>

## NEW ERA NE CLEAN



New Era NE Clean is a multi purpose everyday cleaner designed to dissolve surface dirt that dries quickly and not leaving a film on the floor. With a mop or mechanical floor cleaner, ensure a minimal amount of water is in contact with the floor. When using mops it is essential to ensure it is always well wrung out and kept clean.

**Dilute:** 50-100ml/10 litres of water

## NEW ERA NE PRIME



New Era NE Prime is a water based quick drying primer for all untreated timber Floors, NE Prime limits side-bonding between individual planks and gives a perfect base coat for the New Era NE lacquer.

**Application:** Use a suitable lacquer roller or applicator for perfect results

**Coverage:** 5 ltr can - Approx. 40m<sup>2</sup>

**Re-coat time:** Approx. 30 minutes

## NEW ERA NE LACQUER



New Era NE Lacquer is a two-component water based sports lacquer, especially for high traffic sports floors that can be applied over existing finished floors or on newly sanded floors.

(NE Prime must be used first on sanded floors)

**Application:** Use a suitable lacquer roller or applicator for perfect results

**Coverage:** 5 ltr can - Approx. 40m<sup>2</sup>

**Re-coat time:** Approx. 2.5-3 hours

**Finish:** Silk Matt or Ultra Matt

New Era Gymflex Rubber flooring is a high Performance sports surface that will last a long time when looked after correctly.

## RUBBER CLEANING

It's important to clean rubber frequently to keep the floor surface performance and recommended daily sweeping or vacuuming for floors that are everyday use.

<b>Daily Cleaning</b>	<b>Thoroughly sweep or vacume to remove all loose grit and dirt.</b>
<b>Cleaning every 1-2 weeks</b>	<b>Use NE Rubber renew solution to remove ingrained dirt and grime using NE mop or similar alternative mops with well rung out cloths.</b>

## NEW ERA SPRAY MOP KIT



The New Era Sprey Mop Kit is designed for removing dust, dirt & grime using the specifically combined cleaning formulas or can use a diluted cleaner of choice to suit the floor finish. The sprey mop is easy to use and is rince and streak free, therefore no need for buckets of water and cleaning cloths. Supplied with a machine washable microfiber pad, the mop will help to remove 99.9% of bacteria on all hard serfaces to make a nice, clean and safe floor every time.

## NEW ERA RUBBER RENEW



New Era Rubber Renew is a probiotic enriched cleaner designed for all water- resistance floors in sports and wellness centres. Once diluted it can be used with a mop or mechanical floor cleaner, ensuring a minimal amount of water is in contact with the floor. When using mops it is essential to ensure it is always well wrung out and kept clean.

**Dilute:** 50-100ml/10 Liters of water

New Era LVT Flooring is a high performance sports surface that will last a long time when looked after correctly.

## LVT CLEANING

It is important to clean LVT frequently to keep the floor surface performance and recommended daily sweeping or vacuuming that are in everyday use.

<b>Daily Cleaning</b>	<b>Thoroughly sweep or vacume to remove all loose grit and dirt.</b>
<b>Cleaning every 1-2 weeks</b>	<b>Use NE clean solution to remove ingrained dirt and grime using NE mop or simular alternative mops with well rung out cloths.</b>
<b>Deep Clean every 6-12 months</b>	<b>Clean floor with NE Clean solution and gently scrub the surface with soft brush or mechanical scrubber. Clean on completion with mop to remove any residue.</b>

## NEW ERA SPRAY MOP KIT



The New Era Sprey Mop Kit is designed for removing dust, dirt & grime using the specifically combined cleaning formulas or can use a diluted cleaner of choice to suit the floor finish. The sprey mop is easy to use and is rince and streak free, therefore no need for buckets of water and cleaning cloths. Supplied with a machine washable microfiber pad, the mop will help to remove 99.9% of bacteria on all hard serfaces to make a nice, clean and safe floor every time.

## NEW ERA NE CLEAN



New Era NE Clean is a multi purpose everyday cleaner designed to dissolve surface dirt that dries quickly and not leaving a film on the floor. With a mop or mechanical floor cleaner, ensure a minimal amount of water is in contact with the floor. When using mops it is essential to ensure it is always well wrung out and kept clean.

**Dilute:** 50-100ml/10 litres of water



# GYMFLEX<sup>®</sup>

**A NEW ERA IN SPORTS PERFORMANCE FLOORING**



**03438 410115**

**[www.newerafloorsystems.co.uk](http://www.newerafloorsystems.co.uk)**